



Spring Axles Hanger Kits

Axis Products, Inc. • Elkhart, IN. • Phone 574.266.8282

HANGER KITS

• Fax 574.266.8333 • www.axisproducts.com

DOUBLE-EYE SPRING HANGER KITS

CONFIGURATION	AXIS P/N	DESCRIPTION (CONTENTS)
SINGLE KITS	7024006000 / 7023056000	Single Spring Hanger Kit Short Hangers
	7024004000 / 7023054000	Single Spring Hanger Kit Long Hangers
TANDEM KITS	7024023000 / 7023073000	Tandem Spring Hanger Kit Short Hangers / Short Links
	7024025000 / 7023075000	Tandem Spring Hanger Kit Long Hangers / Short Links
	7024026000 / 7023076000	Tandem Spring Hanger Kit Long Hangers / Medium Links
TRIPLE KITS	7024033000 / 7023083000	Triple Spring Hanger Kit Short Hangers / Short Links
	7024035000 / 7023085000	Triple Spring Hanger Kit Long Hangers / Short Links
	7024036000 / 7023086000	Triple Spring Hanger Kit Long Hangers / Medium Links

SLIPPER SPRING HANGER KITS

CONFIGURATION	AXIS P/N	DESCRIPTION (CONTENTS)
SINGLE KITS	7024043000	Single Slipper Kit
TANDEM KITS	7024044000	Tandem Slipper Kit / 13-4 Equalizer
	7024045000	Tandem Slipper Kit / 13-44 Equalizer
TRIPLE KITS	7024046000	Triple Slipper Kit / 13-4 Equalizer
	7024047000	Tandem Slipper Kit / 13-44 Equalizer

Quality Driven...
Customer Focused

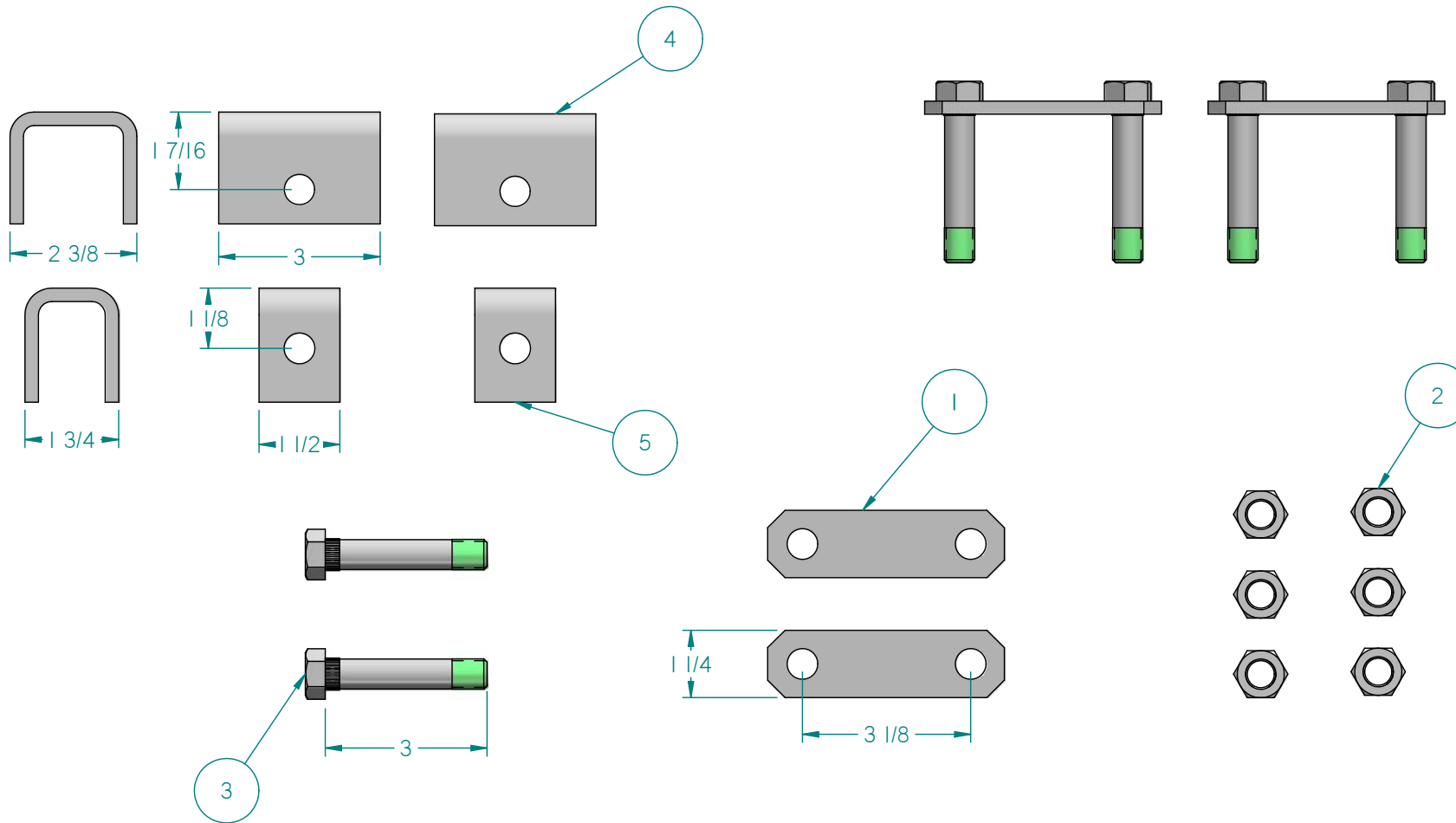

SINGLE KIT PN: 7024006000/ ZINC KIT PN: 7024056000				
ITEM NO.	PART NUMBER	ZINC PN:	DESCRIPTION	QTY.
1	787816181200	750816181200	LONG SHKL LNK 18-12	4
2	786721909181	750721909181	9/16-18 FHN T-LOC NUT-RAW	6
3	786711909181	750711909181	9/16-18 X 3" SHACKLE BOLT	6
4	787815930300	787815930300	REAR HNGR 93003	2
5	787815286000	787815286000	S HNGR 28-6 /1-1/2" HIGH	2

AXIS PRODUCTS, INC.		
TITLE		
7024006000		
SIZE	HANGER KITS	REV
B		1
FILE NAME: HANGER KITS.dft		
SCALE:	WEIGHT:	SHEET 1 OF 11

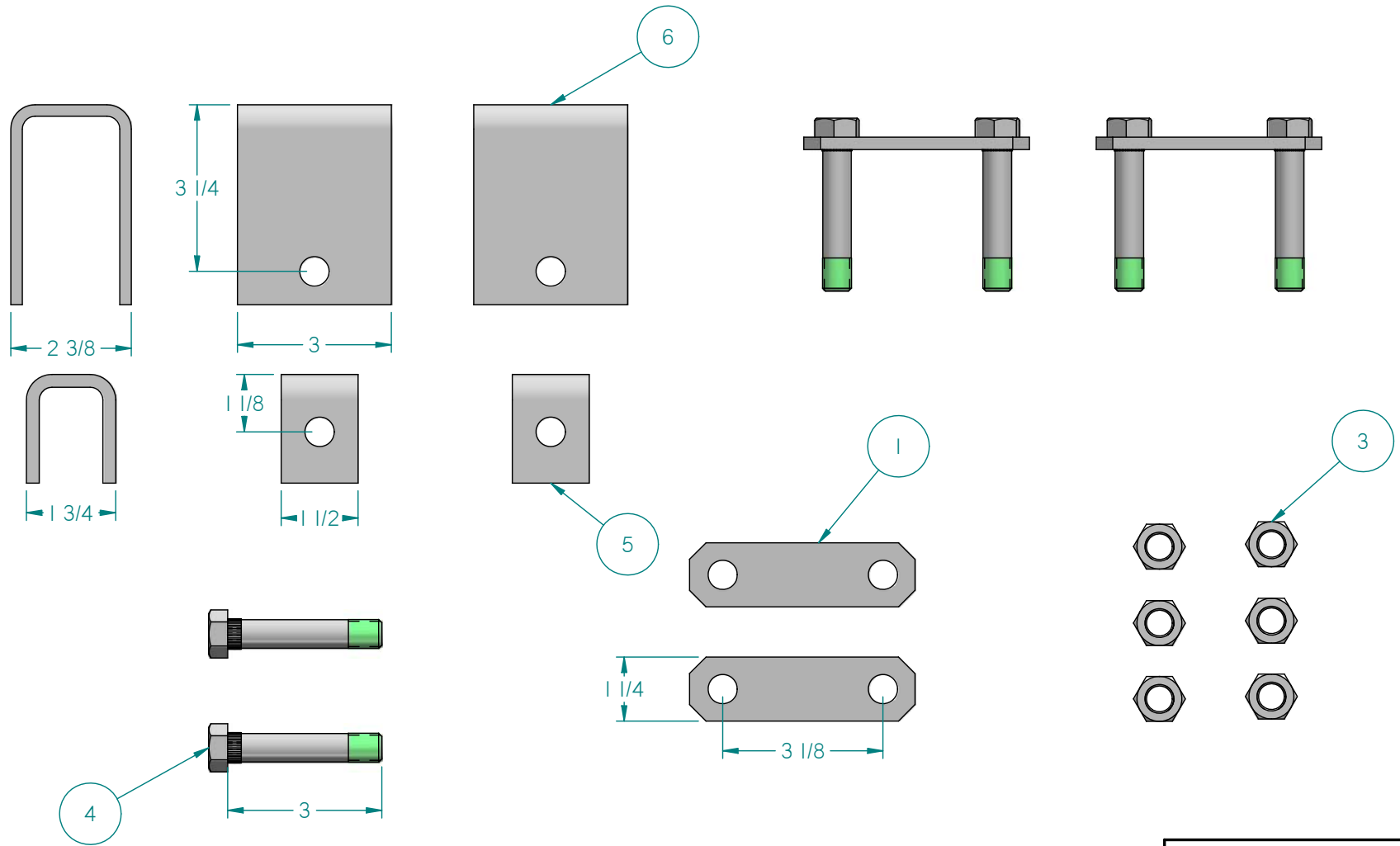

SINGLE KIT PN: 7024004000/ ZINC KIT PN: 7024054000				
ITEM NO.	PART NUMBER	ZINC PN:	DESCRIPTION	QTY.
1	787816181200	750816181200	LONG SHKL LNK 18-12	4
2	786721909181	750721909181	9/16-18 FHN T-LOC NUT-RAW	6
3	786711909181	750711909181	9/16-18 X 3" SHACKLE BOLT	6
4	787815930300	787815930300	REAR HNGR 93003	2
5	787815285000	787815285000	L HNGR 28-5 3/8-1/4" HIGH	2

AXIS PRODUCTS, INC.		
TITLE 7024004000		
SIZE B	HANGER KITS	REV 1
FILE NAME: HANGER KITS.dft		
SCALE:	WEIGHT:	SHEET 2 OF 11

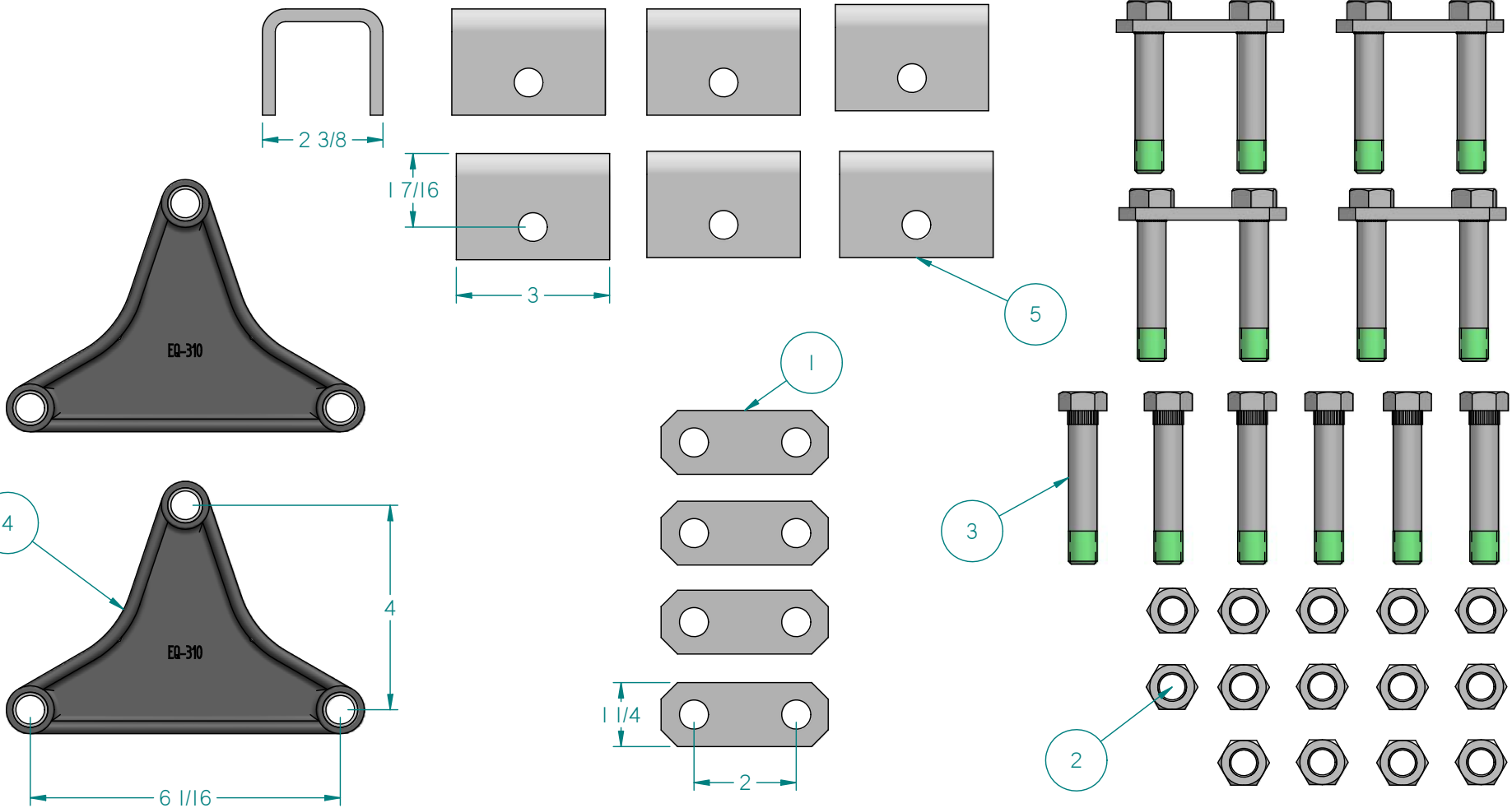

TANDEM KIT PN: 7024023000/ ZINC KIT PN: 7024073000				
ITEM NO.	PART NUMBER	ZINC PN:	DESCRIPTION	QTY.
1	787816181100	750816181200	SHORT SHKL LNK 18-11	8
2	786721909181	750721909181	9/16-18 FHN T-LOC NUT-RAW	14
3	786711909181	750711909181	9/16-18 X 3" SHACKLE BOLT	14
4	770361131000	787815930300	EQUALIZER 13-10 PAINTED	2
5	787815286000	787815286000	S HNGR 28-6 1/1-1/2" HIGH	6

AXIS PRODUCTS, INC.		
TITLE 7024023000		
SIZE B	HANGER KITS	REV 1
FILE NAME: HANGER KITS.dft		
SCALE:	WEIGHT:	SHEET 3 OF 11

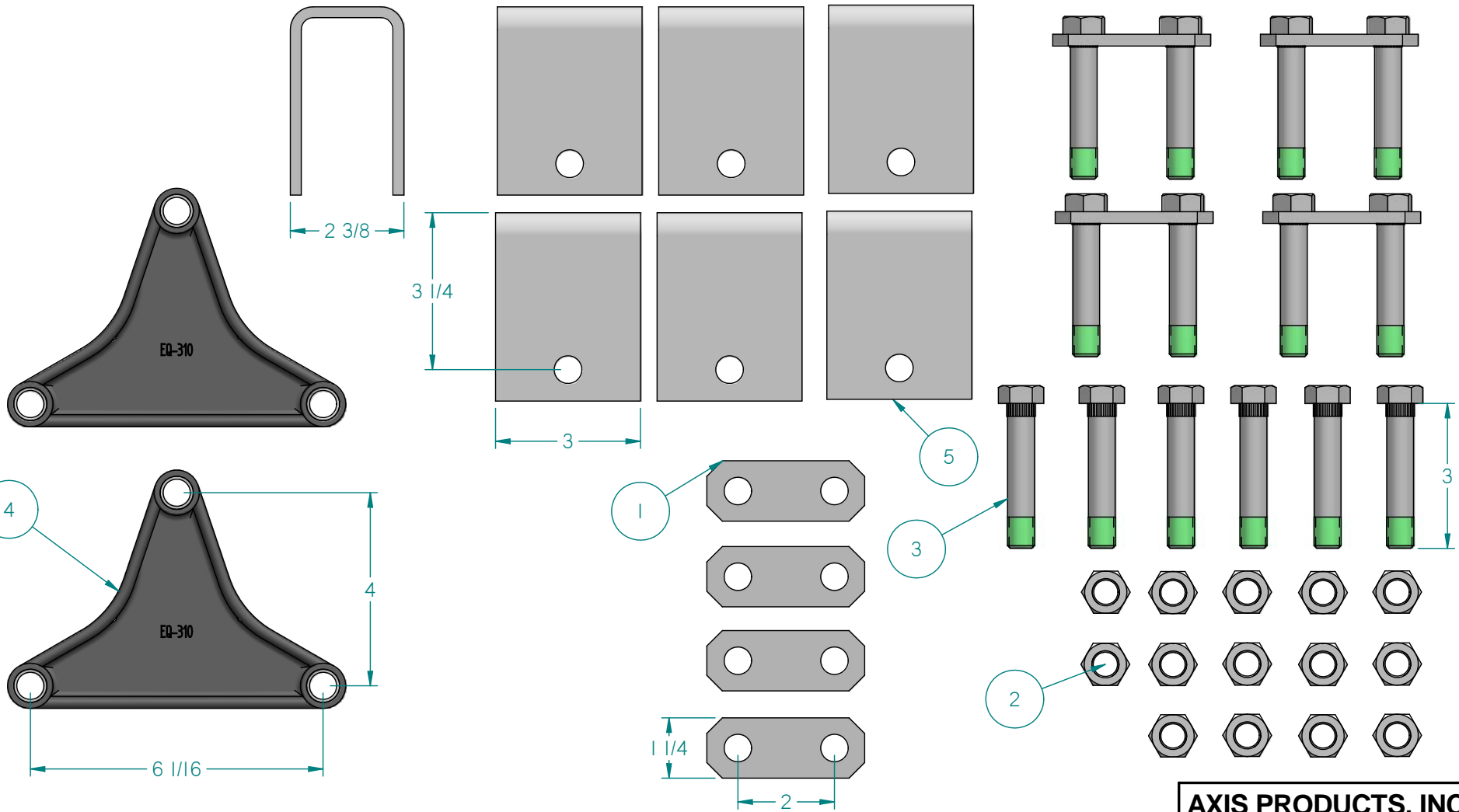

TANDEM KIT PN: 7024025000/ ZINC KIT PN: 7024075000				
ITEM NO.	PART NUMBER	ZINC PN:	DESCRIPTION	QTY.
1	787816181100	750816181200	SHORT SHKL LNK 18-11	8
2	786721909181	750721909181	9/16-18 FHN T-LOC NUT-RAW	14
3	786711909181	750711909181	9/16-18 X 3" SHACKLE BOLT	14
4	770361131000	787815930300	EQUALIZER 13-10 PAINTED	2
5	787815285000	787815285000	L HNGR 28-5 3/8-1/4" HIGH	6

AXIS PRODUCTS, INC.

TITLE: 7024025000

SIZE B: HANGER KITS REV I

FILE NAME: HANGER KITS.dft

SCALE: WEIGHT: SHEET 4 OF 11

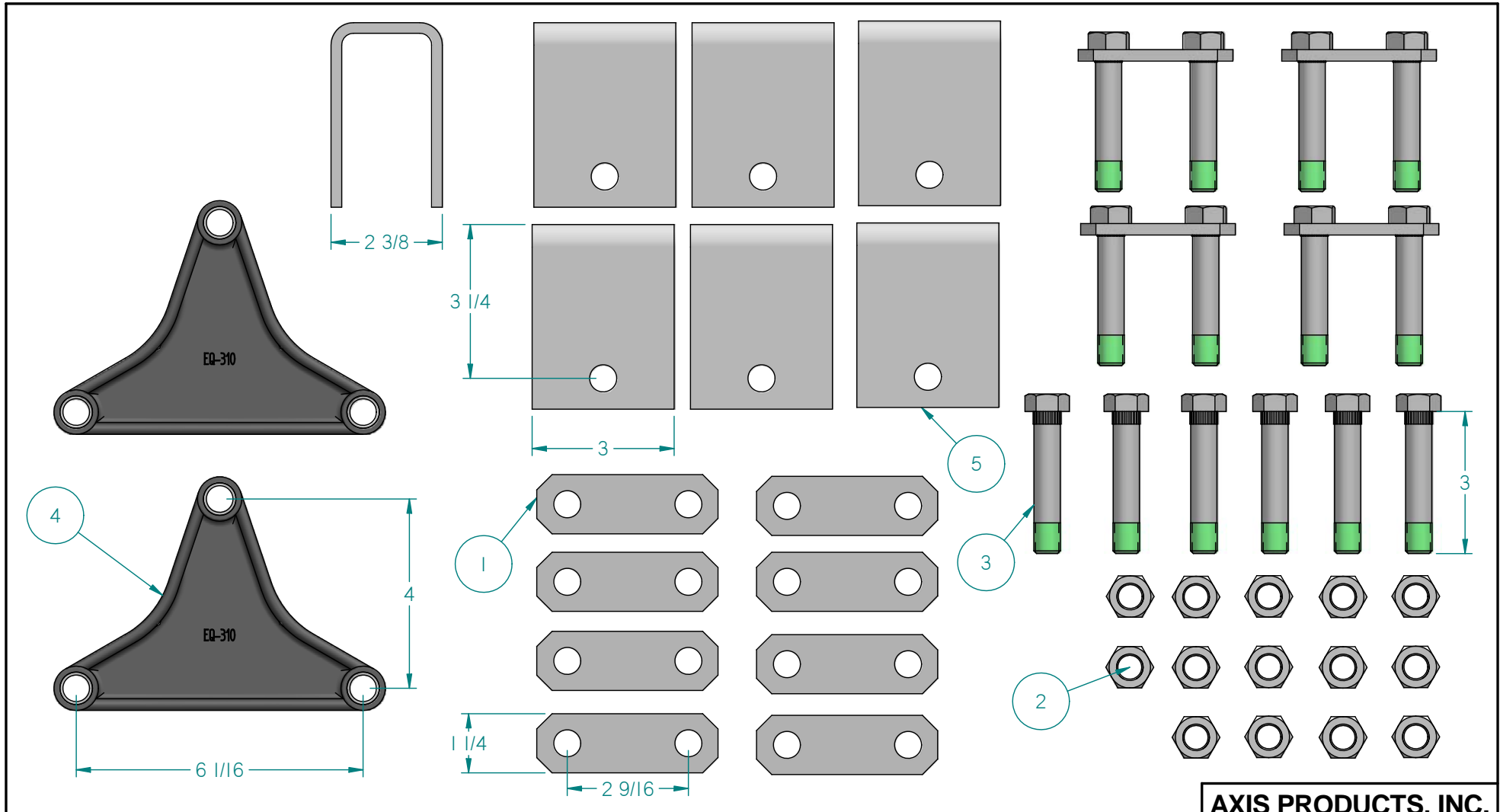

TANDEM KIT PN: 7024026000/ ZINC KIT PN: 7024076000

ITEM NO.	PART NUMBER	ZINC PN:	DESCRIPTION	QTY.
1	787816811500	750816811500	MED. SHKL LNK 18-11.5	8
2	786721909181	750721909181	9/16-18 FHN T-LOC NUT-RAW	14
3	786711909181	750711909181	9/16-18 X 3" SHACKLE BOLT	14
4	770361131000	787815930300	EQUALIZER 13-10 PAINTED	2
5	787815285000	787815285000	L HNGR 28-5 3/8-1/4" HIGH	6

AXIS PRODUCTS, INC.

TITLE: 7024026000

SIZE B: HANGER KITS REV I

FILE NAME: HANGER KITS.dft

SCALE: WEIGHT: SHEET 5 OF 11

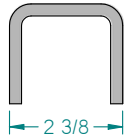
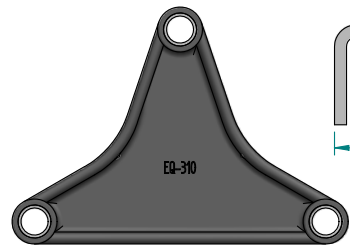

1 7/16

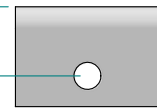
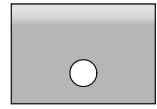

3

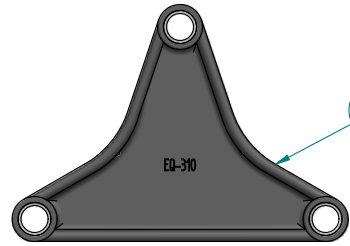
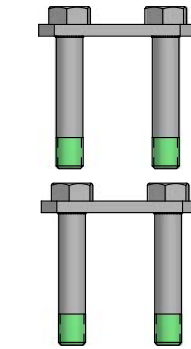
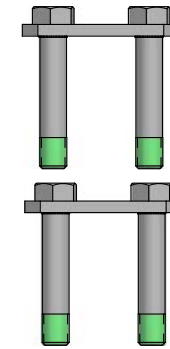
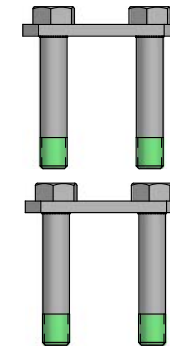
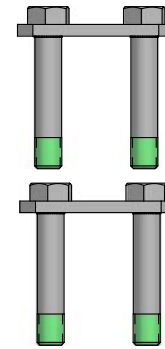
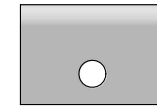
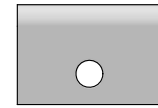
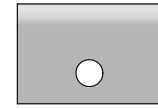

4

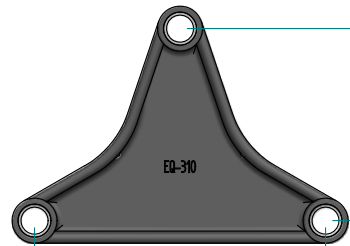
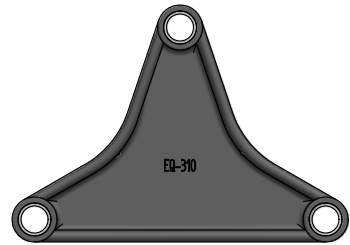

4

6 1/16

5

3

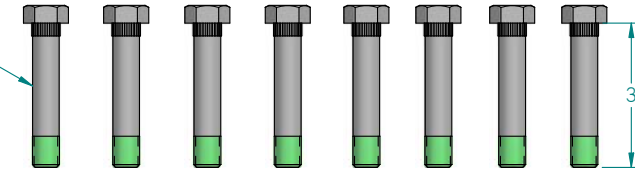

3

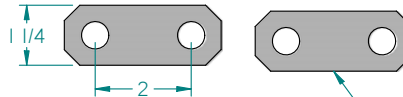
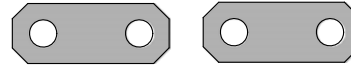
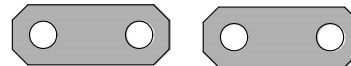
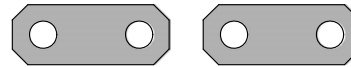

1 1/4

2

1

2

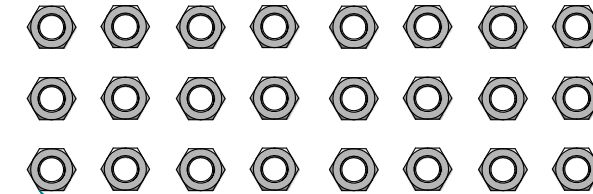

TANDEM KIT PN. 7024033000/ ZINC KIT PN. 7024083000				
ITEM NO.	PART NUMBER	ZINC PN.	DESCRIPTION	QTY.
1	787816181100	750816181200	SHORT SHKL LNK 18-11	16
2	786721909181	750721909181	9/16-18 FHN T-LOC NUT-RAW	24
3	786711909181	750711909181	9/16-18 X 3" SHACKLE BOLT	24
4	770361131000	787815930300	EQUALIZER 13-10 PAINTED	4
5	787815286000	787815286000	S HNGR 28-6 1/1-1/2" HIGH	8

AXIS PRODUCTS, INC.		
TITLE: 7024033000		
SIZE: C	HANGER KITS	REV: I
FILE NAME: HANGER KITS.dft		
SCALE:	WEIGHT:	SHEET 6 OF 11

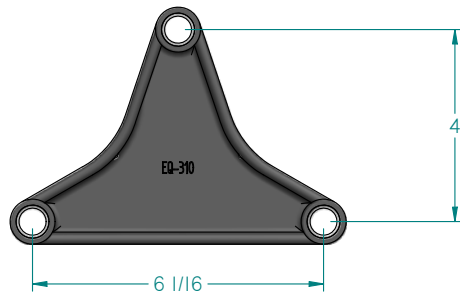
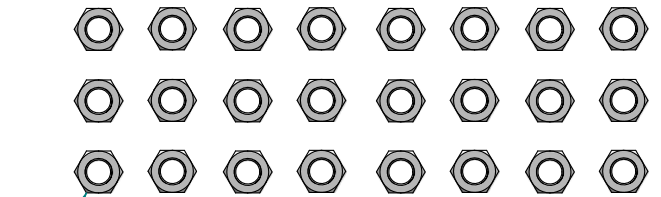
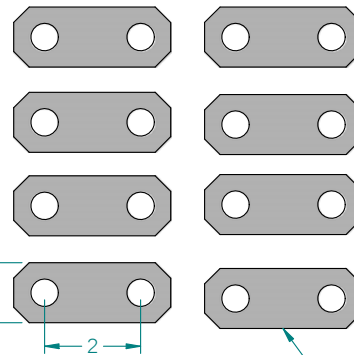
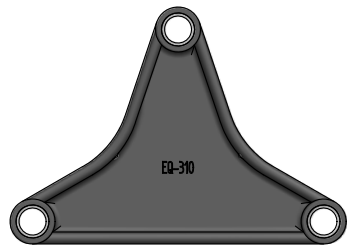
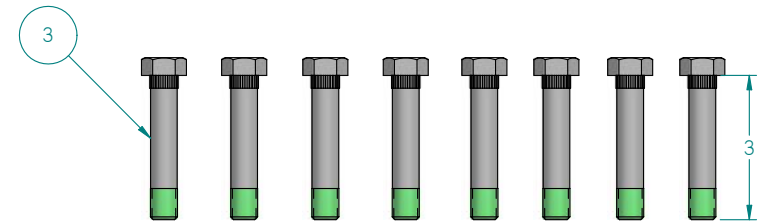
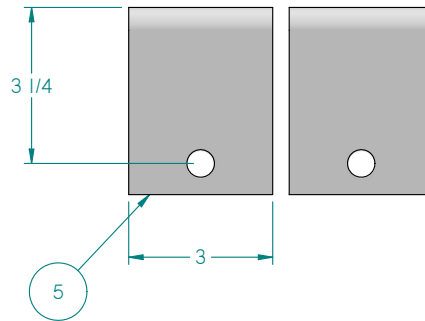
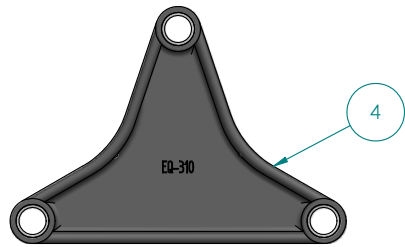
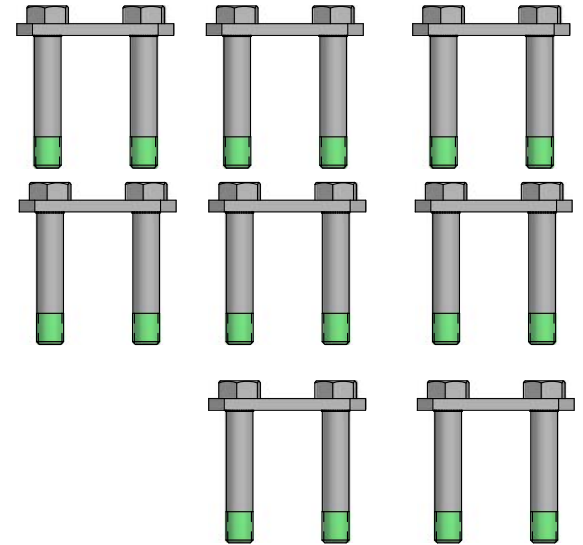
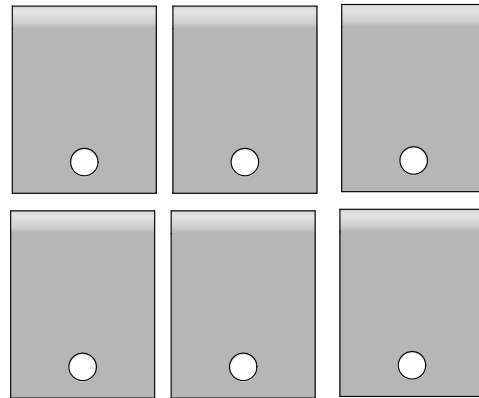
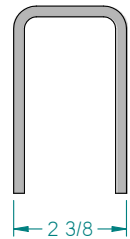
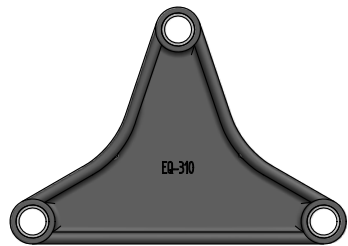

TANDEM KIT PN: 7024035000/ ZINC KIT PN: 7024085000				
ITEM NO.	PART NUMBER	ZINC PN	DESCRIPTION	QTY.
1	787816181100	750816181200	SHORT SHKL LNK 18-11	16
2	786721909181	750721909181	9/16-18 FHN T-LOC NUT-RAW	24
3	786711909181	750711909181	9/16-18 X 3" SHACKLE BOLT	24
4	770361131000	787815930300	EQUALIZER 13-10 PAINTED	4
5	787815285000	787815285000	L HNGR 28-5 3/8" HIGH	8

AXIS PRODUCTS, INC.		
TITLE: 7024035000		
SIZE: C	HANGER KITS	REV: I
FILE NAME: HANGER KITS.dft		
SCALE:	WEIGHT:	SHEET 7 OF 11

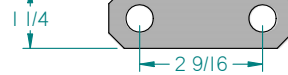
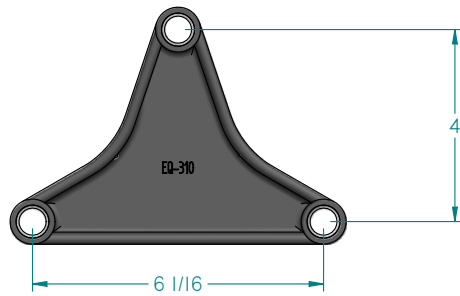
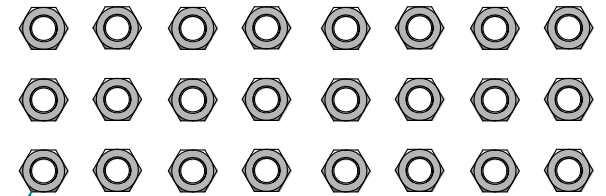
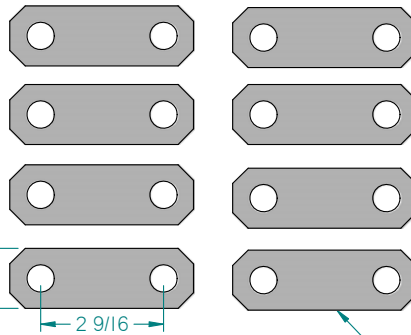
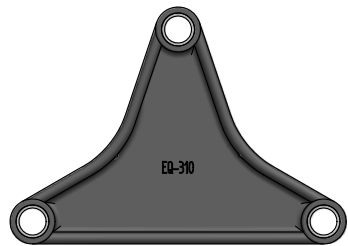
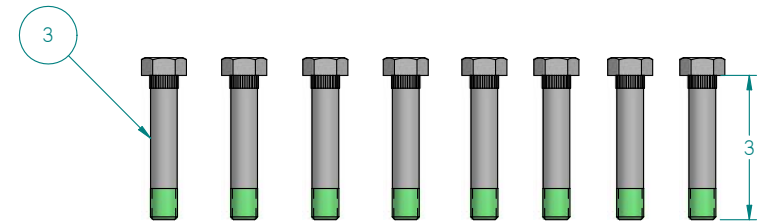
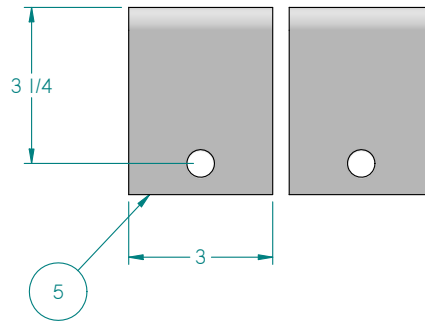
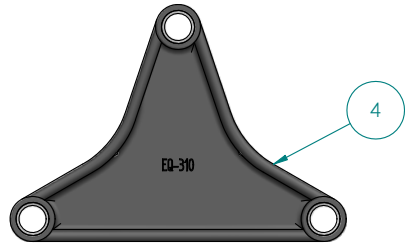
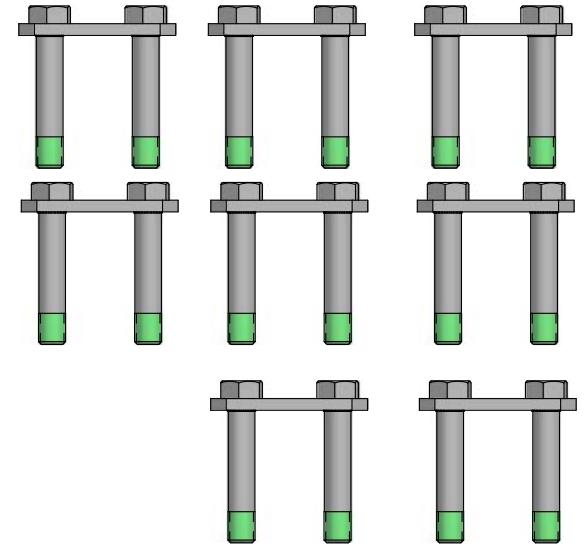
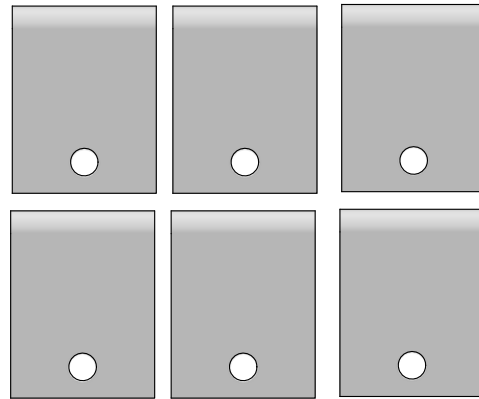
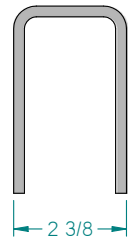
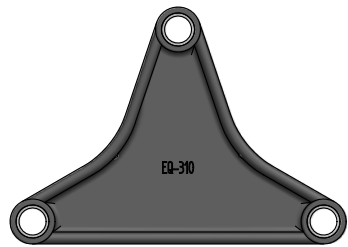

TANDEM KIT PN: 7024036000/ ZINC KIT PN: 7024086000				
ITEM NO.	PART NUMBER	ZINC PN	DESCRIPTION	QTY.
1	787816811500	750816811500	MED. SHKL LNK 18-11.5	16
2	786721909181	750721909181	9/16-18 FHN T-LOC NUT-RAW	24
3	786711909181	750711909181	9/16-18 X 3" SHACKLE BOLT	24
4	770361131000	787815930300	EQUALIZER 13-10 PAINTED	4
5	787815285000	787815285000	L HNGR 28-5 1/3-1/4" HIGH	8

AXIS PRODUCTS, INC.

TITLE		
7024036000		
SIZE	HANGER KITS	REV
C		I
FILE NAME: HANGER KITS.dft		
SCALE:	WEIGHT:	SHEET 8 OF 11

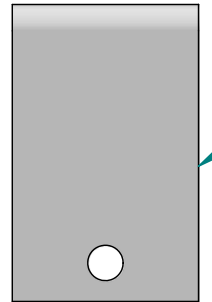
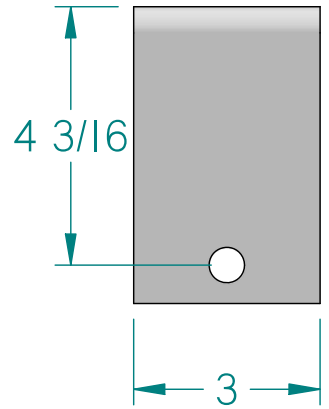
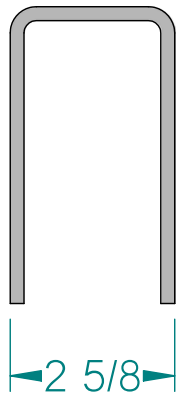

5

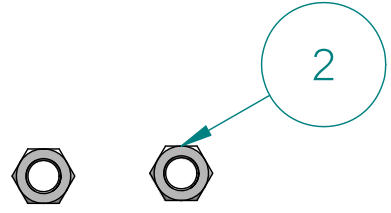

3

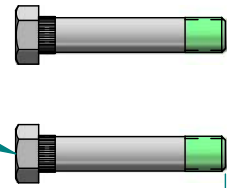

3

6

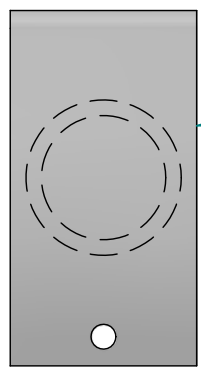
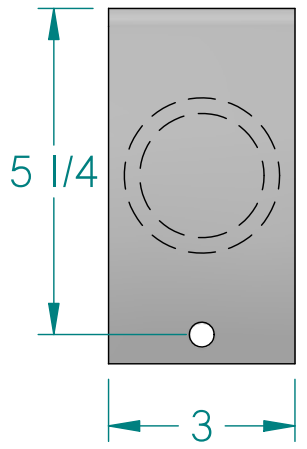

1

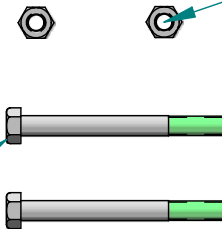

3 1/4

4

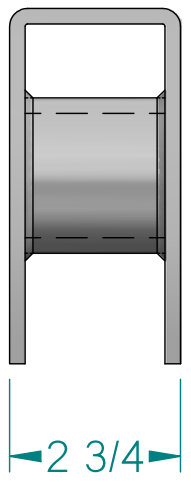

SINGLE SLIPPER KIT PN: 7024043000

ITEM NO.	PART NUMBER	DESCRIPTION	QTY.
1	750721305180	5/16-18 FH NUT T-LOC ZINC	2
2	786721909181	9/16-18 FHN T-LOC NUT-RAW	2
3	786711909182	9/16-18X3.5 inch SHACKLE BOLT	2
4	770815281000	SLPR FRONT HANGER 28-1	2
5	787815286000	S HNGR 28-6 /1-1/2" HIGH	2
6	770815302800	SLPR REAR HANGER 30-28	

AXIS PRODUCTS, INC.

TITLE: 7024043000

SIZE B	HANGER KITS SLIPPER	REV 1
--------	---------------------	-------

FILE NAME: HANGER KITS SLIPPER.dft

SCALE: WEIGHT: SHEET 1 OF 8

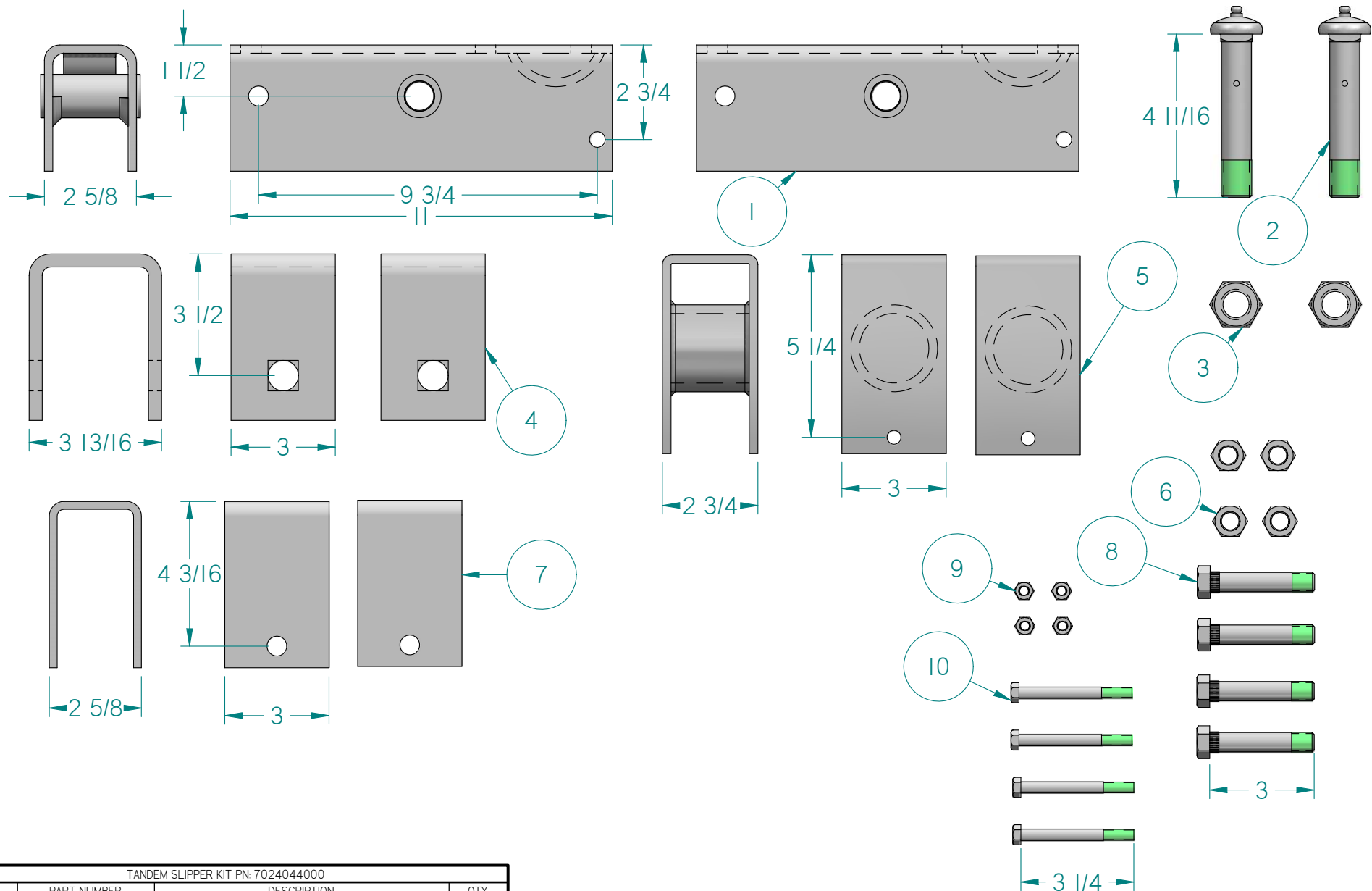

TANDEM SLIPPER KIT PN: 7024044000			
ITEM NO.	PART NUMBER	DESCRIPTION	QTY.
1	770362134000	EQUALIZER SLPR REG 13-4	2
2	770711214090	7/8-9 X 4.7 SLIP EQUAL BOLT	2
3	770721214090	7/8-9 T-LOC NUT/SLIP BOLT	2
4	770815291000	SLPR EQUAL HANGER 29-1	2
5	770815302800	SLPR REAR HANGER 30-28	2
6	786721909181	9/16-18 FHN T-LOC NUT-RAW	4
7	770815281000	SLPR FRONT HANGER 28-1	2
8	786711909182	9/16-18X3.5" SHACKLE BOLT	4
9	750721305180	5/16-18 FH NUT T-LOC ZINC	4
10	770711305180	5/16-18X3.25 SLIP KEEP BOLT	4

AXIS PRODUCTS, INC.

TITLE 7024044000		
SIZE C	HANGER KITS SLIPPER	REV 1
FILE NAME: HANGER KITS SLIPPER.dft		
SCALE:	WEIGHT:	SHEET 2 OF 8

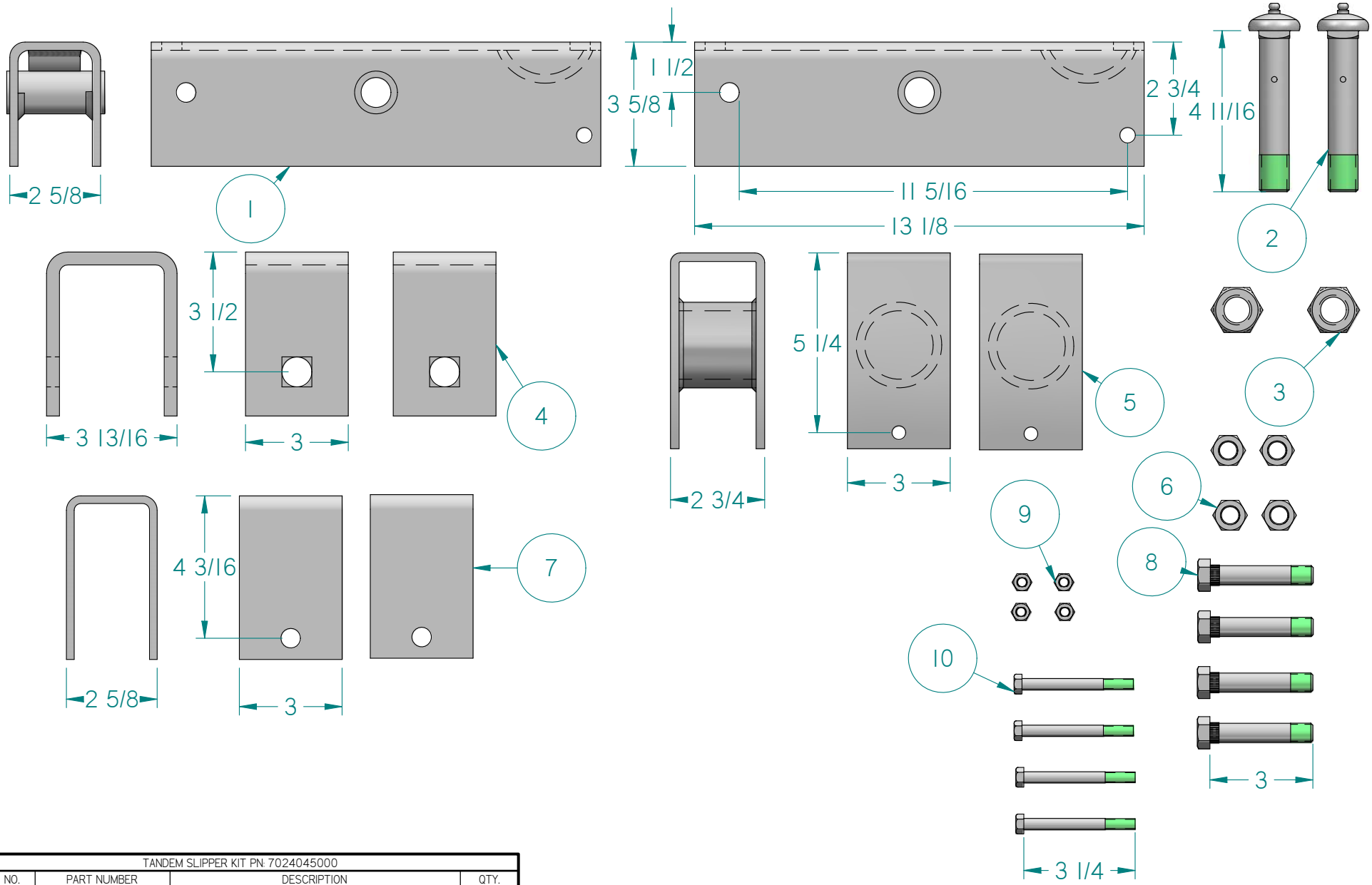

TANDEM SLIPPER KIT PN: 7024045000			
ITEM NO.	PART NUMBER	DESCRIPTION	QTY.
1	770362134410	EQUALIZER SLPR LONG 13-44	2
2	770711214090	7/8-9 X 4.7 SLIP EQUAL BOLT	2
3	770721214090	7/8-9 T-LOC NUT/SLIP BOLT	2
4	770815291000	SLPR EQUAL HANGER 29-1	2
5	770815302800	SLPR REAR HANGER 30-28	2
6	786721909181	9/16-18 FHN T-LOC NUT-RAW	4
7	770815281000	SLPR FRONT HANGER 28-1	2
8	786711909182	9/16-18X3.5" SHACKLE BOLT	4
9	750721305180	5/16-18 FH NUT T-LOC ZINC	4
10	770711305180	5/16-18X3.25 SLIP KEEP BOLT	4

AXIS PRODUCTS, INC.

TITLE: 7024045000

SIZE C	HANGER KITS SLIPPER	REV I
FILE NAME: HANGER KITS SLIPPER.dft		
SCALE:	WEIGHT:	SHEET 3 OF 8

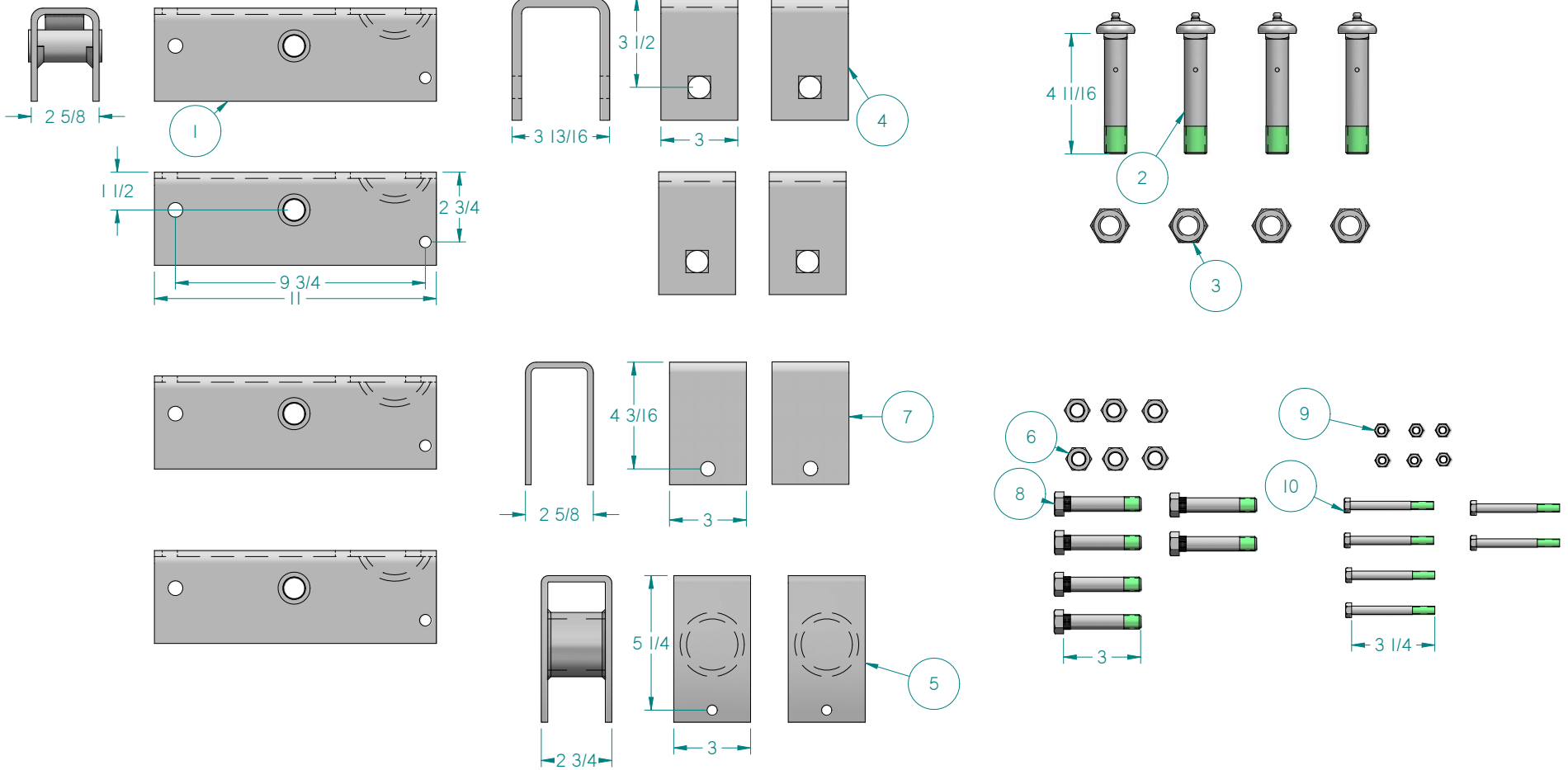

TANDEM SLIPPER KIT PN: 7024046000			
ITEM NO.	PART NUMBER	DESCRIPTION	QTY.
1	770362134000	EQUALIZER SLPR REG 13-4	4
2	770711214090	7/8-9 X 4.7 SLIP EQUAL BOLT	4
3	770721214090	7/8-9 T-LOC NUT/SLIP BOLT	4
4	770815291000	SLPR EQUAL HANGER 29-1	4
5	770815302800	SLPR REAR HANGER 30-28	2
6	786721909181	9/16-18 FH N T-LOC NUT-RAW	4
7	770815281000	SLPR FRONT HANGER 28-1	2
8	786711909182	9/16-18X3.5" SHACKLE BOLT	4
9	750721305180	5/16-18 FH NUT T-LOC ZINC	6
10	770711305180	5/16-18X3.25 SLIP KEEP BOLT	6

AXIS PRODUCTS, INC.
 23720 Reedy Dr. Elkhart, In 46515
 TITLE: 7024046000
 SIZE: D HANGER KITS SLIPPER I REV: 1
 FILE NAME: HANGER KITS SLIPPER.dwg
 SCALE: WEIGHT: SHEET 4 OF 8

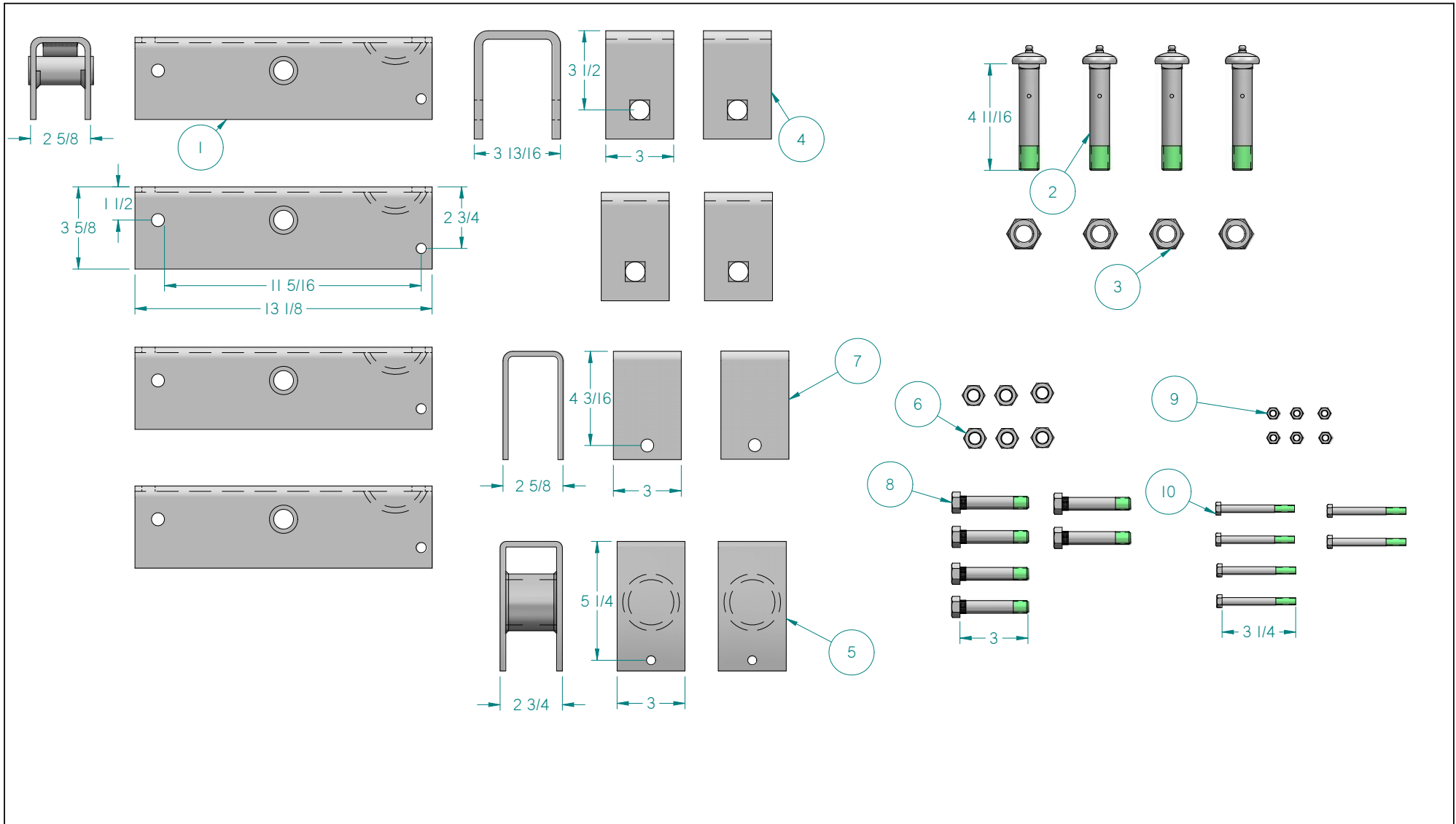

TANDEM SLIPPER KIT PN 7024047000			
ITEM NO.	PART NUMBER	DESCRIPTION	QTY.
1	770362134410	EQUALIZER SLPR LONG 13-44	4
2	770711214090	7/8-9 X 4.7 SLIP EQUAL BOLT	4
3	770721214090	7/8-9 T-LOC NUT/SLIP BOLT	4
4	770815291000	SLPR EQUAL HANGER 29-1	4
5	770815302800	SLPR REAR HANGER 30-28	2
6	786721909181	9/16-18 FH N-T-LOC NUT-RAW	6
7	770815281000	SLPR FRONT HANGER 28-1	2
8	78671909182	9/16-18X3.5 SHACKLE BOLT	6
9	750721305180	5/16-18 FH NUT T-LOC ZINC	6
10	770711305180	5/16-18X3.25 SLIP KEEP BOLT	6

AXIS PRODUCTS, INC.
 23720 Reedy Dr. Elkhart, In 46515
 TITLE: 7024047000
 SIZE: D HANGER KITS SLIPPER I REV: 1
 FILE NAME: HANGER KITS SLIPPER.dwg
 SCALE: WEIGHT: SHEET 5 OF 8